

### DC/DC CONVERTERS

### HIGH DENSITY, 2:1 WIDE INPUT RANGE

#### FEATURES

- 2:1 INPUT RANGE
- SINGLE AND DUAL OUTPUTS
- EXTENDED TEMPERATURE RANGE:  
-40°C TO +85°C
- INDUSTRY STANDARD PINOUTS
- SIX-SIDED SHIELDING
- LOW PROFILE 0.4 INCH
- 15.6 WATTS/CUBIC INCH
- REMOTE ON-OFF/SYNC FUNCTION
- OUTPUT VOLTAGE TRIM: ±10%

#### DESCRIPTION

The WPC20R Series is a family of high performance DC/DC converters that offers regulated outputs with two input ranges of 18-36V and 36-75V over a wide temperature range of -40°C to +85°C.

An output voltage adjust of ±10% is provided. In addition, a CMOS/TTL open-collector compatible remote on-off (shutdown) pin is available to put the

#### APPLICATIONS

- TELECOMMUNICATION APPLICATIONS
- BATTERY POWERED SYSTEMS
- PORTABLE INSTRUMENTS
- PROCESS CONTROL EQUIPMENT
- TRANSPORTATION EQUIPMENT
- DISTRIBUTED POWER SYSTEMS

unit into a low consumption (typically < 1mA) standby mode.

The 200 KHz switching frequency and forward converter topology provide optimum performance in a space saving package. The design uses all surface mounted components including magnetics, to provide enhanced reliability.

The entire circuit is constructed on an aluminum substrate printed circuit board which provides improved thermal performance.

#### SIMPLIFIED CIRCUIT DIAGRAM

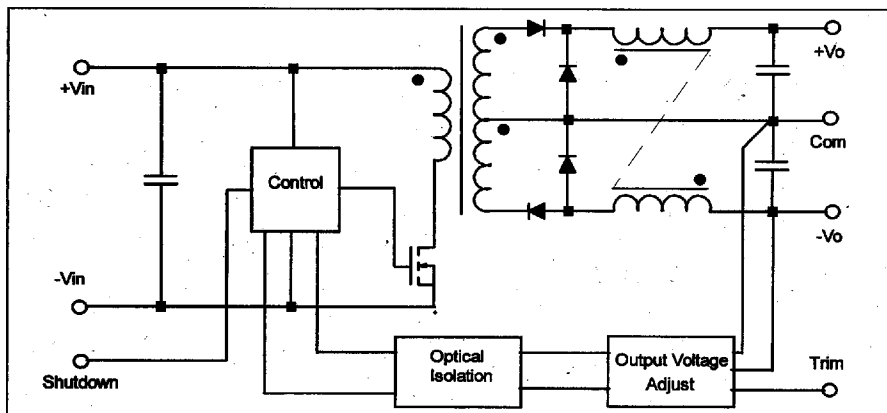

# ELECTRICAL SPECIFICATIONS

Specifications typical at  $T_A = +25^\circ\text{C}$ , nominal input voltage, rated output current unless otherwise specified.

MODEL	NOMINAL INPUT VOLTAGE (VDC)	RATED OUTPUT VOLTAGE (VDC)	OUTPUT CURRENT		INPUT CURRENT		EFFICIENCY (%)
			MIN LOAD (A)	RATED LOAD (A)	MIN LOAD (A)	RATED LOAD (A)	
WPC20R24S05	24	5	0.400	4.000	0.115	1.060	77
WPC20R24S12	24	12	0.167	1.670	0.115	1.030	80
WPC20R24S15	24	15	0.133	1.330	0.115	1.030	80
WPC20R24D12	24	$\pm 12$	$\pm 0.200$	$\pm 0.833$	0.115	1.030	80
WPC20R24D15	24	$\pm 15$	$\pm 0.167$	$\pm 0.667$	0.115	1.030	80
WPC20R48S05	48	5	0.400	4.000	0.060	0.520	80
WPC20R48S12	48	12	0.167	1.670	0.060	0.500	84
WPC20R48S15	48	15	0.133	1.330	0.060	0.500	84
WPC20R48D12	48	$\pm 12$	$\pm 0.200$	$\pm 0.833$	0.060	0.500	82
WPC20R48D15	48	$\pm 15$	$\pm 0.167$	$\pm 0.667$	0.060	0.500	82

NOTE: Other input to output voltages may be available. Please consult factory.

## COMMON SPECIFICATIONS

Specifications typical at  $T_A = +25^\circ\text{C}$ , nominal input voltage, rated output current unless otherwise specified.

PARAMETER	CONDITIONS	MIN	TYP	MAX	UNITS
<b>INPUT</b>					
Voltage Range		18	24	36	VDC
Reflected Ripple Current*	Measured with External Capacitor	36	48	75	VDC
			100		mAp-p
<b>INPUT CONTROL/SYNC**</b>					
Shutdown LOW Voltage (OFF Voltage)	Referenced to -Vin			2.0	V
Shutdown HIGH Voltage (ON Voltage)	Referenced to -Vin	3.5		9.0	V
Total Standby Quiescent Current	Current into +Vin		1		mA
<b>ISOLATION</b>					
Rated Voltage		500			VDC
Test Voltage	60 Hz, 10 Seconds	1500			VDC
Resistance			10		GΩ
Capacitance			2000		pF
Leakage Current	$V_{iso} = 240\text{VAC}, 60\text{Hz}$		180		μArms
<b>OUTPUT</b>					
Rated Power				20	Watts
Voltage Setpoint Accuracy				$\pm 1.5$	%
Output Adjust Range***		$\pm 8$	$\pm 10$	$\pm 12$	%
Temperature Coefficient			$\pm 0.02$		%/°C
Line Regulation					
Singles	Low Line to High Line			$\pm 0.1$	%
Duals	Low Line to High Line			$\pm 0.5$	%
Load Regulation					
Single	Min Load to Rated Load			$\pm 0.5$	%
Duals	Min Load to Rated Load			$\pm 2$	%
Ripple & Noise					
Single	BW = 5 Hz to 20 MHz		60	100	mVp-p
Duals	BW = 5 Hz to 20 MHz		50	100	mVp-p
<b>GENERAL</b>					
Switching Frequency			200		KHz
MTTF per MIL-HDBK-217	Circuit Stress Method				
Ground Benign	$T_A = +25^\circ\text{C}$		280		kHr
	$T_A = +60^\circ\text{C}$		75		kHr
Package Weight			38		g
<b>TEMPERATURE</b>					
Specification		-25		+60	°C
Operation	Derate Linearly From 60°C	-40		+110	°C
Storage		-55		+125	°C

### NOTES:

\* External filter capacitor is required for normal operation. Recommend 100V 56μF (48Vin) or 50V 100μF (24Vin) low ESR electrolytic.

\*\* For shutdown, the shutdown pin must be actively pulled below 2V or shorted to -Vin. For normal operation, the shutdown pin should be either left open or tied to a logic HIGH of between 3.5 and 9V.

\*\*\* When output voltage is adjusted via trim input, total load power should not exceed 20W, and total load current should not exceed rated load current.

## ORDERING INFORMATION

**WPC20R** **xyzz** /H

Device Family \_\_\_\_\_  
 Indicates 20 Watt Regulated DC/DC converter

Model Number \_\_\_\_\_  
 Selected from Table of Electrical Characteristics  
 Where:  
 xx = Input Voltage  
 y = Number of Outputs (Single "S", Dual "D")  
 zz = Output Voltage

Screening Option \_\_\_\_\_

## REMOTE ON/OFF CONTROL

Logic Compatibility .....CMOS or Open Collector TTL  
 EC On .....Open Circuit or > 3.5VDC  
 EC Of .....< 2VDC  
 Shutdown Idle Current .....1mA  
 Control Common .....-Vin

## ABSOLUTE MAXIMUM RATINGS

Short Circuit Protection .....Continuous  
 Internal Power Dissipation .....5W  
 Lead Temperature (soldering 10seconds, max) .....+300°C  
 Maximum Case Temperature.....+110°C

## MECHANICAL

**TOP VIEW**

**SIDE VIEW**

**PIN CONNECTIONS**

PIN #	SINGLES	DUALS
1	+VIN	+VIN
2	-VIN	-VIN
3	No Pin	No Pin
4	RemoteOn/Off	RemoteOn/Off
5	No Pin	+VOUT
6	+VOUT	Common
7	-VOUT	-VOUT
8	Trim	Trim

**BOTTOM VIEW**

**NOTES:** All dimensions are in inches (millimeters).  
 GRID: 0.100 inches (2.54 millimeters)  
 Pin Placement Tolerance: ±0.015  
 Marked with: specific model ordered, date code, job code.  
**MATERIAL:** Units are encapsulated in a low thermal resistance molding compound which has excellent chemical resistance, wide operating temperature range, and good electrical properties under high humidity environments. The encapsulant and outer shell of the unit have UL94V-0 ratings. Lead material is brass with a solder plated surface to allow ease of solderability.

## THERMAL DERATING

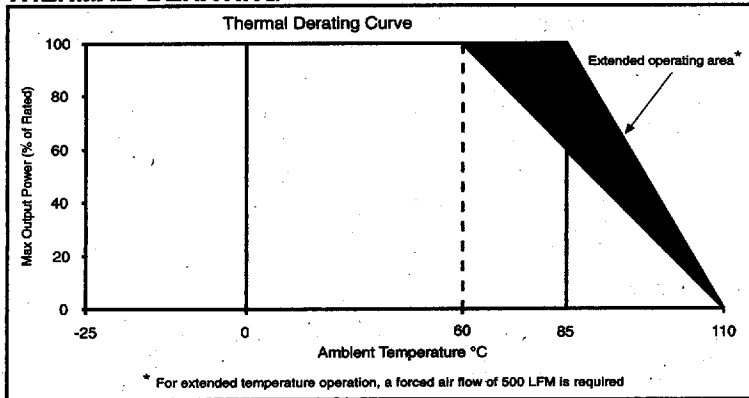

## OUTPUT TRIM ADJUST

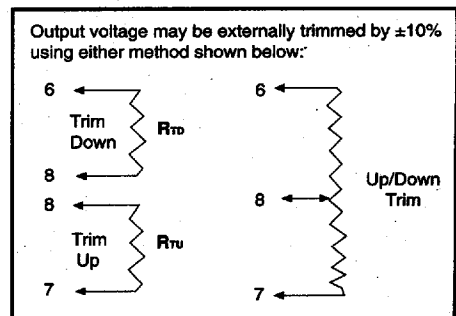

# TYPICAL PERFORMANCE CURVES

$T_A = +25^\circ\text{C}$ , nominal input voltage, rated load, recommended external components applied, unless otherwise specified.

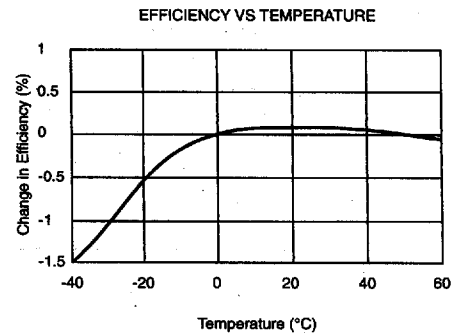
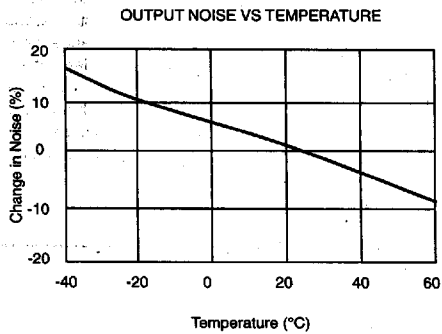
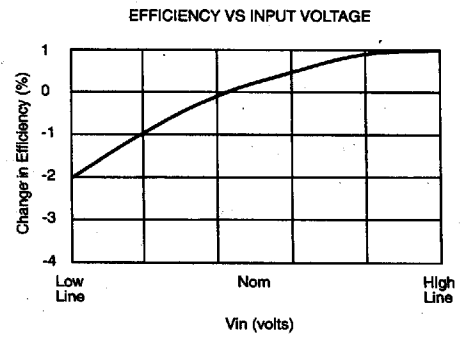
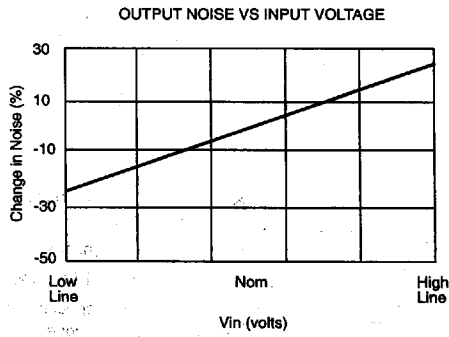
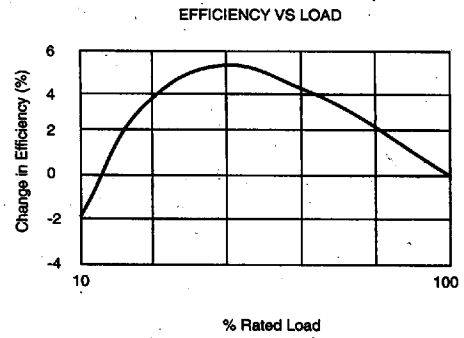
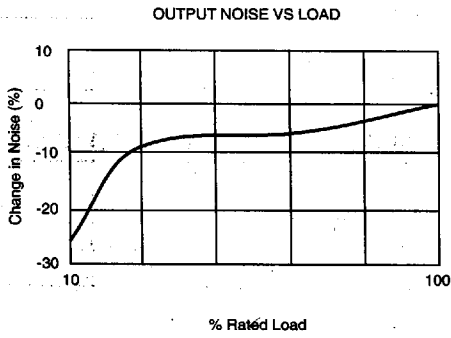

The information provided herein is believed to be reliable; however, Power Convertibles assumes no responsibility for inaccuracies or omissions. Power Convertibles assumes no responsibility for the use of this information, and all use of such information shall be entirely at the user's own risk. Prices and specifications are subject to change without notice. No patent rights or licenses to any of the circuits described herein are implied or granted to any third party. Power Convertibles does not authorize or warrant any Power Convertibles product for use in life support devices and/or systems. Power Convertibles is a trademark of Power Convertibles Corporation.